















LIVING SPACES

Dean C/E King Assembly Instructions

Hardware Diagram includes factory installed bolts and washers for side rails attachment.

| A | B | D | E | F | G | I | J | S | T | Y | Z |
|---|---|---|---|---|---|---|---|---|---|---|---|
|  |  |  |  |  |  |  |  |  |  |  |  |
| φ6*15MM | φ8*30MM | φ6MM | φ8MM | φ12CM | | φ8MM | | φ10MM | φ6*20MM | | φ10MM |
| 8PCS | 0PCS | 16PCS | 0PCS | 4PCS | 4PCS | 1PC | 8PCS | 4PCS | 8PCS | 1PC | 4PCS |

②

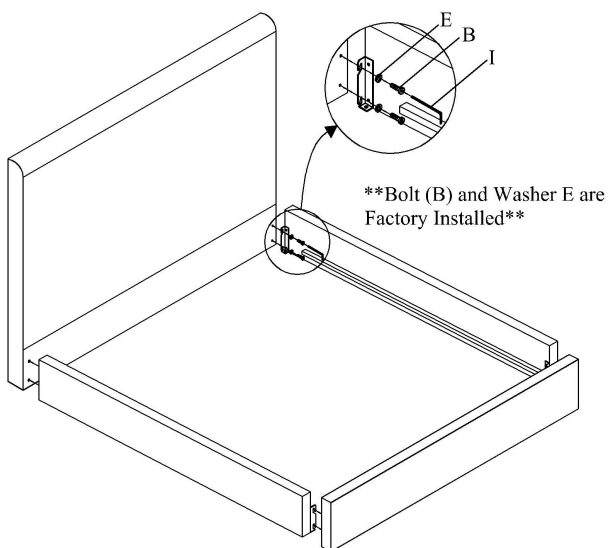

③

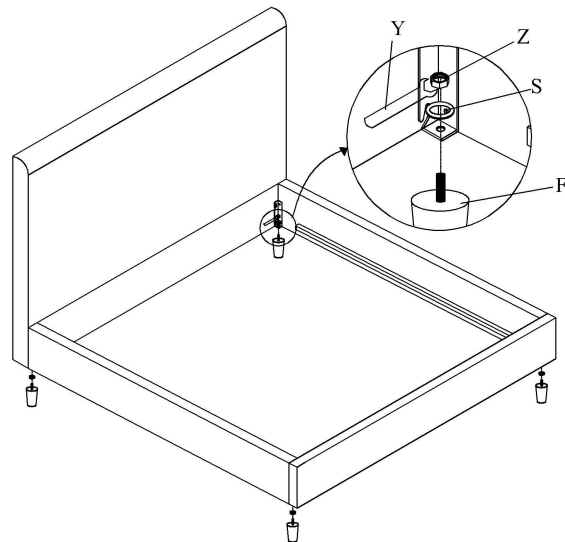

Step#1

Retrieve bed feet and center support legs from zipper behind the headboard.

Step#2

Attach side rails to headboard and footboard using Bolt (B), Washer (E) and Wrench (I).

Step#3

Attach bed feet (F) to the headboard and footboard, then tighten/secure Nut (Z) with Wrench (Y) until snug.

CONGRATULATIONS ON YOUR NEW BED PURCHASE













~Warning:do not move bed after final assembly as it may result in damages to floor and/or bed.~



LIVING SPACES

Dean C/E King Assembly Instructions

Hardware Diagram includes factory installed bolts and washers for side rails attachment.

| A | B | D | E | F | G | I | J | S | T | Y | Z |
|---|---|---|---|---|---|---|---|---|---|---|---|
|  |  |  |  |  |  |  |  |  |  |  |  |
| φ6*15MM | φ8*30MM | φ6MM | φ8MM | φ12CM | | φ8MM | | φ10MM | φ6*20MM | | φ10MM |
| 8PCS | 0PCS | 16PCS | 0PCS | 4PCS | 4PCS | 1PC | 8PCS | 4PCS | 8PCS | 1PC | 4PCS |

⑤

⑥

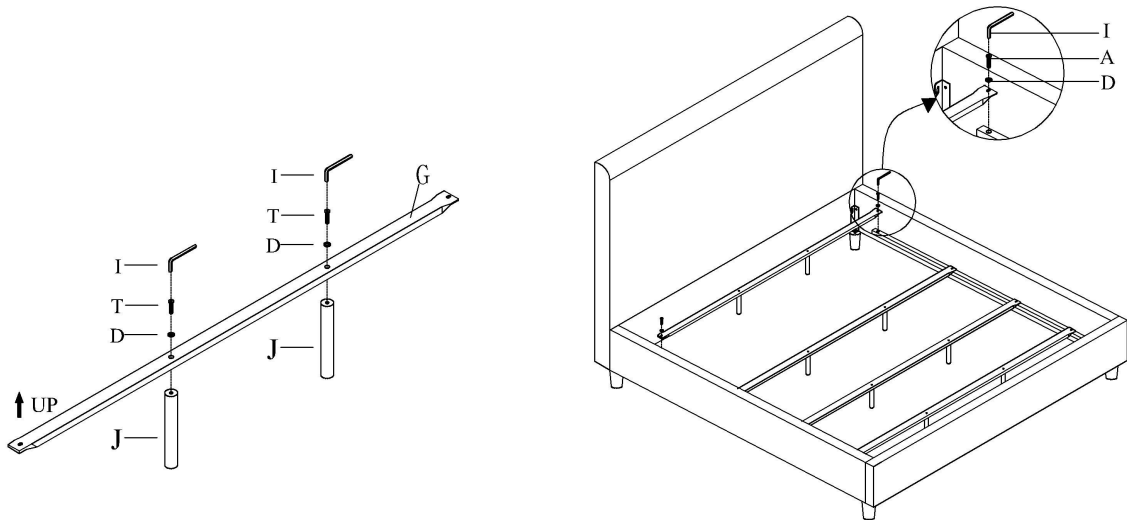

Step#4

Move/place bed into final position in bedroom.

Step#5

Attach steel center support legs (J) to the Metal slat (G) using Wrench (I), Bolt (T) and Washer (D).

Step#6

Attach steel slat support system to full length steel side rail support cleats (flat side facing up).

Verify the metal slats are inserted properly into support cleats and center support legs are perpendicular to the floor for full support.

CONGRATULATIONS ON YOUR NEW BED PURCHASE

~Warning:do not move bed after final assembly as it may result in damages to floor and/or bed.~