





# Assembly Instructions For



## BDCANNS TALBERT 2-DRAWER NIGHTSTAND

Thank you for purchasing this quality product. Be sure to check all packing materials carefully for small parts, which may have come loose inside the carton during shipment. Identify and count all parts and compare with the **HARDWARE LIST** below.

**Caution:** Please read instructions thoroughly before unpacking assembly parts.

1. We recommend that you assemble this product with the assistance of another person; this will make assembly easier, and will help to eliminate damage to the product or injury to persons during assembly.
2. Please do not over tighten screws or bolts until the assembly is completed.
3. Please put all parts on a non-abrasive floor before assembly, and follow the assembly steps to assemble your newly purchased product correctly and efficiently.

NO.	Hardware List	Q' TY
1	 $\varnothing 5/16" * 18 * 3/4" L$ Allen Bolt	12
	$\varnothing 5/16" * \varnothing 13mm$ Spring washer	12
	$\varnothing 5/16" * \varnothing 19mm * 1.5mm$ Flat washer	12
	 Allen wrench (4mm)	1

LIST OF PARTS AND HARDWARE:			
NO.	Description		Q' TY
A		Cabinet	1
B		Metal legs	4

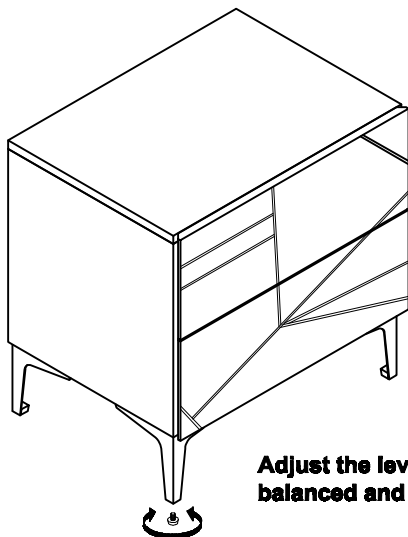
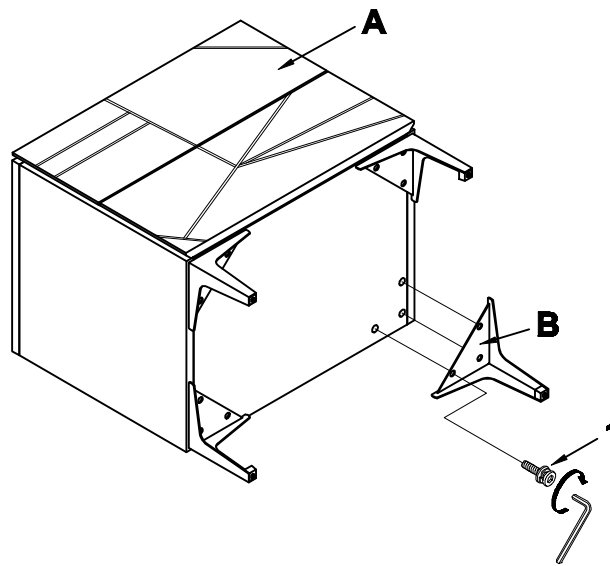

**Leveler 4pcs**  
Adjust the levelers until they are balanced and touching the floor.

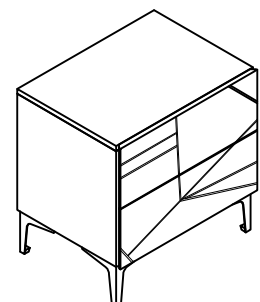

Assembly completed

Made in Vietnam